

MADE-TO-MEASURE

BLIND BUYING GUIDE



MEASURING FOR YOUR BLINDS

TOOLS REQUIRED

Metal Measuring Tape, Pen & Paper

HOW TO MEASURE

1. Only use a metal measuring tape and record your measurements in mm.
2. Measurements must be accurate for a perfect fit. We will make the necessary allowances to ensure the blind fits the window.
3. Decide on how you want the blind fitted – ‘Inside Recess’ is within the window frame or ‘Outside Recess – Exact Size’ is to your desired point on the wall outside of the window frame.
4. Always measure the width first (across the window) and then the drop (top to bottom) in 3 places.
5. Record your measurements in the same order.
6. Look for any obstructions such as handles. You will need to take their position into account to ensure a perfect fit.
7. Finally, re-check your width and drop measurements to ensure accuracy.



MEASURING FOR YOUR BLINDS

INSIDE RECESS (RECESS)

Measure at the 6 positions shown (3 horizontal, 3 vertical) and record the smallest dimension as the 'Recess Size'. (e.g. in PIC 1 your width measurement will be 918mm and your drop measurement is 993mm). Provide the width measurement first.

OUTSIDE RECESS (EXACT SIZE)

If you plan on fitting your blind outside the window recess the blind should be slightly larger than the inside recess to give better coverage. Take your inside recess measurement and add 200mm / 20cm / 1inch / to the width and the drop, this is what you will enter when ordering your blind, next choose outside recess when asked for your fitting type.

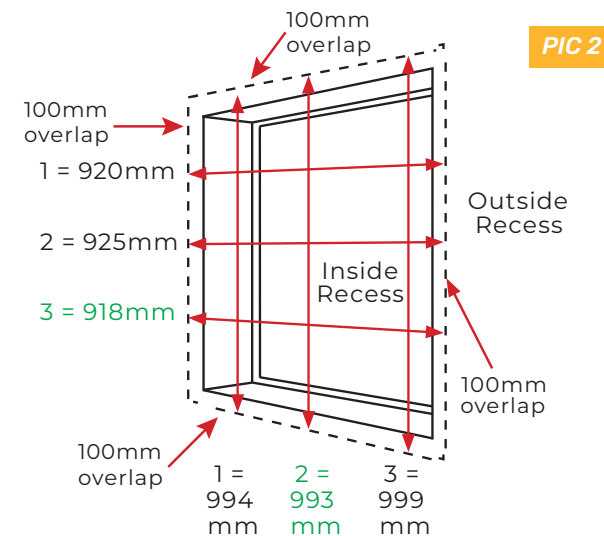
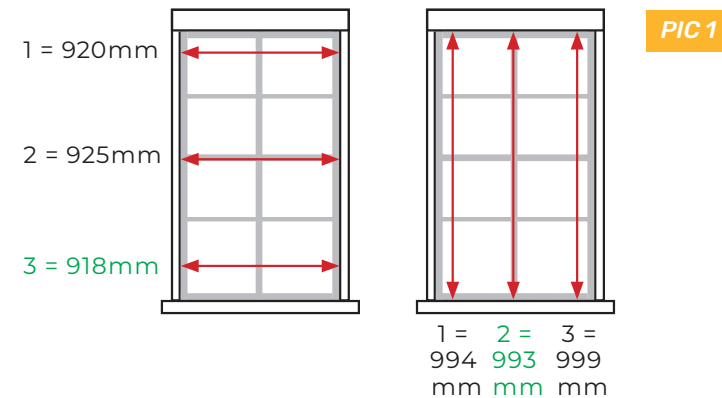

MEASURING FOR YOUR BLINDS

SQUARE BAY WINDOWS

To create a perfect fit please follow the step-by-step guides:

Step 1. Find the head rail depth of your chosen blind in the chart provided below.

HEAD RAIL DEPTHS

Roller Classic	55mm
Roller Cassette	80mm
Roman Classic	48mm
Roman Cassette	80mm
Zebra	80mm
Vertical Classic Top Fix	50mm
Vertical Classic Face Fix	100mm
Vertical Cassette	80mm

Step 2. Measure the central window (measurement A) from left to right and deduct the head rail depth twice from this measurement. E.g. for roller classic, deduct 110mm from this measurement.

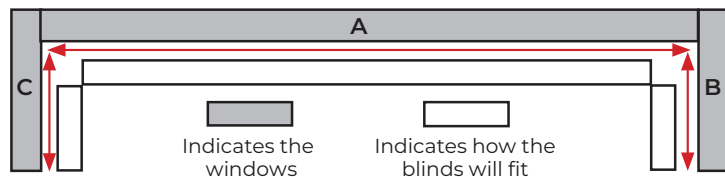

Step 3. Measure sides (B and C) into the back corners of the bay. This will be the width of the rail.

Step 4. Deduct the head rail depth off measurement B and C. E.g. for roller classic, deduct 55mm from each measurement.

Step 5. Order all three blinds as an exact measurement.

Step 6. For the drop, measure from where you want the top of the blind to be, to where you want it to finish. If you measure to the sill, deduct 10mm to allow the blind to move freely.

Note: If window handles protrude, take the measurement of the projection and add to each measurement A, B and C (if applicable).

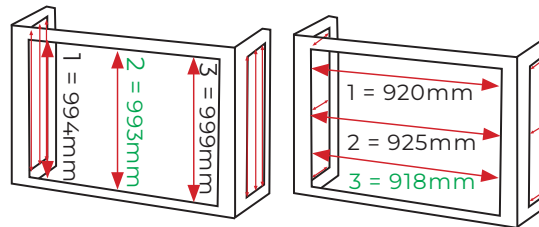

TIP!

For both the width and drop measurements, measure in three places for each window. For the width, measure top, middle and bottom and for the drop measure left, middle and right. Your window might not be square, so always give us the smallest measurement.

MEASURING FOR YOUR BLINDS

ANGLED BAY WINDOWS

The trick to measuring angled bays is to make a template. Follow our step-by-step guide:

Step 1. Find the head rail depth of your chosen blind in the chart provided (please refer to the previous page “measuring your blinds – Square Bay Windows”).

Step 2. Place two pieces of paper together. Using the head rail depth as your measurement, mark each piece of paper with a line in the same position.

Step 3. Position your pieces of paper on the window sill and ensure both the line marks meet up as shown.

Step 4. Using a pencil, mark the window sill where the edge of the paper meets the sill.

Step 5. Do this for both corners of the bay.

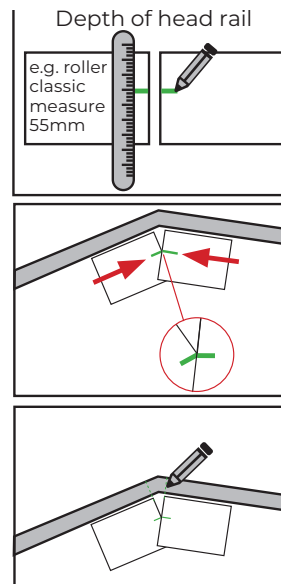

Step 6. Measure between each section as shown below. This will determine the width of each blind needed. All blinds should be ordered as exact. (A, B & C measurements)

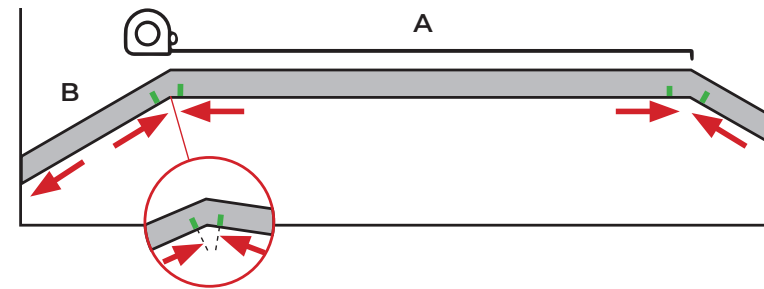

Step 7. For the drop measure from where you want the top of the blind to be down to the sill or floor.

Recess

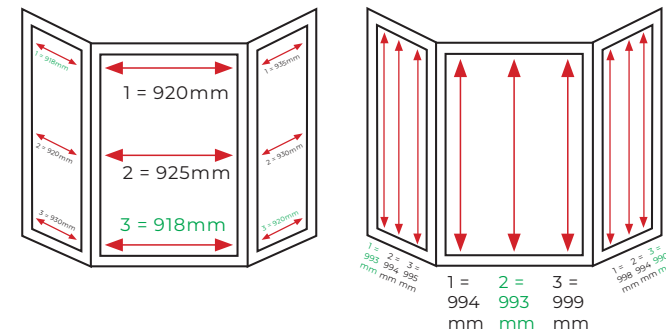

TIP!

For both the width and drop measurements, measure in three places for each window. For the width, measure top, middle and bottom and for the drop measure left, middle and right. Your window might not be even, so always give us the smallest measurement.

GUIDELINES

GENERAL TIPS FOR MADE-TO-MEASURE BLINDS

- All our blinds are made to be safe and are in line with all British Standards. Ensure all blinds are installed correctly and the cord safety clip is attached accordingly. Please ensure that you install blinds correctly and follow the instructions provided.
- Due to the packing methods on Roman blinds, Velvets and Pile fabrics there may be some creasing and pressure marks which should disappear over time.
- To ensure your Roman blinds looks its best, we recommend using a steamer to help eliminate creases. Do not use excessive pressure or heat as this can distort the fabric.
- We pride ourselves on excellent quality. All blinds are inspected and photographed prior to packing and dispatching to ensure your order arrives perfectly.
- All blinds ordered as inside recess will have 10mm deducted automatically from the width and drop measurement provided to allow them to sit comfortably in recess.
- All blinds are custom made to the dimensions provided at the time of ordering. Refunds and exchanges cannot be given on any Made-to-Measure blinds that have been incorrectly ordered unless they are faulty.



MADE-TO-MEASURE BLINDS

BENEFITS OF MADE-TO-MEASURE BLINDS

- With many different versatile finishes, blinds can add the finishing touch to a room. Roller blinds are particularly good for bathrooms and kitchens, Roman blinds with a blackout lining suit a bedroom, and for a larger window or patio doors, a vertical blind is a better option.
- Our made to measure blinds are custom made to fit your window perfectly. Choose from a collection of Roller, Roman, Zebra or Vertical blinds.
- A comprehensive range of fabrics are available to include, print, woven, sheer, blackout, light filtering and waterproof finishes.
- A choice of lining qualities are available for Roman blinds depending on your desired finish.
- Different heading options and blind finishes to pick from.
- Layering a window with two or more products can be a great way to achieve maximum light and privacy control.



WHAT KIND OF BLIND?

ROLLER

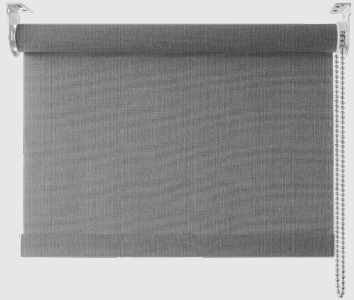

Roller blinds are fabric blinds that roll around a cylindrical barrel when raised or lowered. We have a wide range of textures, plains and prints, some of which can be printed on translucent, waterproof and blackout bases.

ROMAN

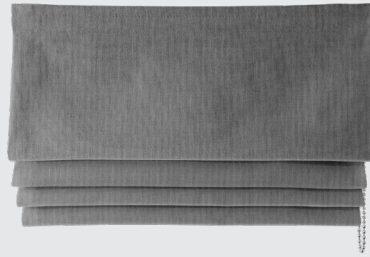

Roman blinds are made from fabric that hangs in neat folds when open, and sits flat when fully extended. Various lining qualities are available.

ZEBRA



Zebra Roller blinds work with two layers of fabrics. The special panels created in the fabric means you get complete control of light and privacy.

VERTICAL



Vertical blinds have louvres of fabric that can be open, closed and tilted to control light and privacy. A wide choice of fabrics are available. Choose from a wand or chain control option.

ROLLER BLIND SPECIFICATION

BLIND SIZES

- Minimum Size: Width 300mm x Drop 300mm
- Maximum Size: Width 2800mm x Drop 5000mm*
- The fabric will be 35mm narrower from both sides together than the rail/tube to accommodate the control chain.

*Depending on fabric choice, some fabrics are restricted to a maximum width or drop.

HEADING STYLES

- A classic header is great value and quality. The fabric is attached to a slimline metal tube. This option is particularly useful for areas with limited space.
- A cassette header is a premium option. The sleek metal box, available in white, silver or anthracite, hides the mechanism. The cassette in most cases is covered with the same fabric as the blind. White end caps are used on the ends of the cassette.

CLASSIC HEADER

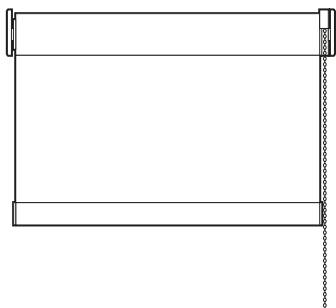

CASSETTE HEADER

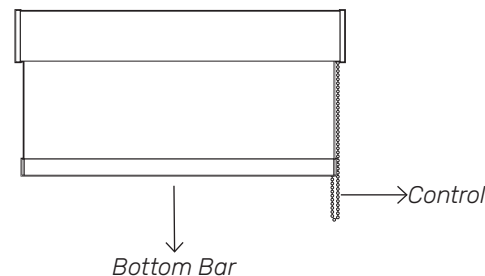

OPTIONS

- **Fabric:** Plain colours, blackout, woven textures, jacquards, sheers, waterproof, light filtering and printed designs.
- **Bottom Bar:** This is to give weight and stability to the fabric and comes wrapped in the same fabric as the blind for a coordinated finish. Also available in black, white, silver and anthracite.
- **Control:** The chain allows you to operate the blind up and down and can be positioned on the left or right side. Colour options are white or black plastic, with an option to upgrade to a metal chain in nickel or brass at a surcharge.
- **Motorised:** Control your blinds via remote, app, voice or pull with motorised blinds. Available as a hardwired or wireless system, motorised blinds also allow your window coverings to be controlled with your smart home system or smart speaker.



Blinds Child Safety Awareness: Keep all cords and chains out of the reach of children using the safety hook, which has been provided for you. Loose cords or chains should never be tied together.



ROMAN BLIND SPECIFICATION

BLIND SIZES

- Minimum Size: Width 300mm x Drop 300mm
- Maximum Size: Width 2600mm x Drop 4000mm
- Most blinds over 1300mm wide will come with two joins down either side of the blind. We will always pattern match these joins.

HEADING STYLES

- A classic header is great value and quality. The fabric is attached to a slimline white, metal headrail. This is particularly useful for areas with limited space.
- A cassette header is a premium option. The sleek metal box, available in white, silver or anthracite, hides the mechanism. The cassette in most cases is covered with the same fabric as the blind. White end caps are used on the ends of the cassette.

OPTIONS

- **Fabric:** Plains, textures, jacquards and printed designs.
- **Stack Style:** Waterfall – When the blind is pulled up, the fabric pleats create a waterfall effect. Stacked – the pleats sit directly behind each other.
- **Bottom Bar:** To give the fabric stability, there is a steel bar inserted into a pocket between lining and face fabric.
- **Lining:** All Roman blinds are lined. Select from standard polycotton, luxury satin or blackout lining. We have a blackout bonded lining to provide extra insulation.
- **Control:** The chain allows you to operate the blind up and down and can be positioned on the left or right side. Choose from white or black plastic, or nickel or brass metal.
- **Motorised:** Control your blinds via remote, app, voice or pull with motorised blinds. Available as a hardwired or wireless system, motorised blinds also allow your window coverings to be controlled with your smart home system or smart speaker.

CLASSIC HEADER

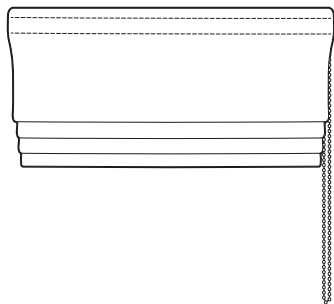

CASSETTE HEADER

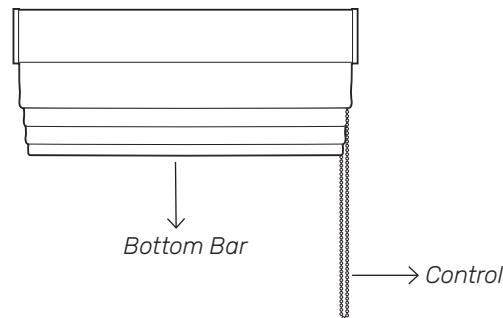

Blinds Child Safety Awareness: Keep all cords and chains out of the reach of children using the safety hook, which has been provided for you. Loose cords or chains should never be tied together.



WATERFALL

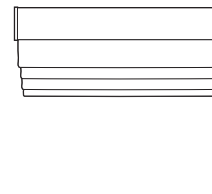

STACKED

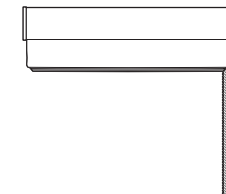

ZEBRA BLIND SPECIFICATION

BLIND SIZES

- Minimum Size: Width 300mm x Drop 300mm
- Maximum Size: Width 2750mm x Drop 4000mm
- Fabric will be 35mm narrower from both sides together than the rail/tube to accommodate the control chain on manual blinds.

AVAILABLE SYSTEMS

- A cassette header is a premium option. The sleek metal box, available in white, silver or anthracite, hides the mechanism. The cassette in most cases is covered with the same fabric as the blind. White end caps are used on the ends of the cassette..
- On larger blinds, the cassette is bigger to house the extra mechanics.

OPTIONS

- **Fabric:** Plain with sheer panels, plain blackout with sheer panels, textures with sheer panels.
- **Bottom Bar:** This is to give weight and stability to the fabric. Our classic option comes with a cylindrical white metal bottom bar that sits in the bottom loop of the fabric. Upgrade to cassette to get a sleek bottom bar, available covered in the same fabric or white silver or anthracite metal.
- **Control Chain:** Choose to have the control on the left or right. Select a black or white plastic chain, or a brass or nickel metal chain.
- **Motorised:** Control your blinds via remote, app, voice or pull with motorised blinds. Available as a hardwired or wireless system, motorised blinds also allow your window coverings to be controlled with your smart home system or smart speaker.

CLASSIC HEADER

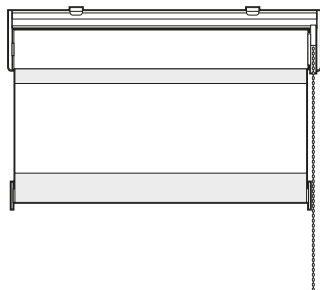

CASSETTE HEADER

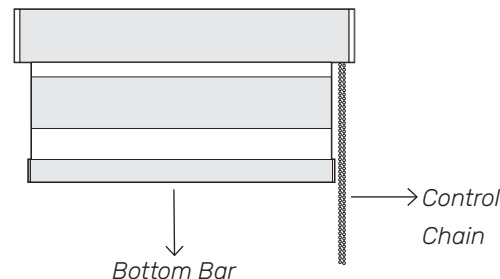

Blinds Child Safety Awareness: Keep all cords and chains out of the reach of children using the safety hook, which has been provided for you. Loose cords or chains should never be tied together.



VERTICAL BLIND SPECIFICATION

BLIND SIZES

- Minimum Size: Width 300mm x Drop 300mm
- Maximum Size: Width 2800mm x Drop 4000mm

CLASSIC HEADER

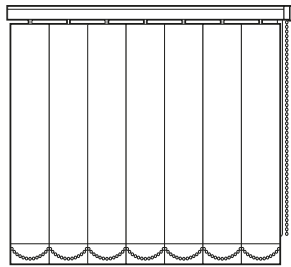

CASSETTE HEADER

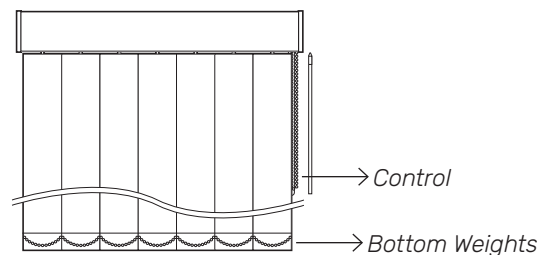

HEADER STYLES

- A classic header is great value and quality. The fabric is attached to a slimline white, metal headrail. This is particularly useful for areas with limited space.
- A cassette header is a premium option. The sleek metal box, available in white, silver or anthracite, hides the mechanism. The cassette in most cases is covered with the same fabric as the blind. White end caps are used on the ends of the cassette.

OPTIONS

- **Fabric:** The louvres are 89mm wide.
- **Louvre Stack:** When the blind is fully open, the fabric louvres can hang to the left or right or be split to hang equally either side.
- **Bottom Weights:** Weights are needed to keep each louvre stable. Choose a standard finish and the weights will come with white stabilising chain, or pick a premium finish and the weights will be concealed in a pocket at the bottom of the louvre with no chains.
- **Control:** Wand or chain options are available. The chains can be positioned on the left or right hand side of the blind. A wand option will be positioned in the middle of the blind.
- **Brackets:** Top Fix (to fit inside the recess of a window) or Face Fix (good for fitting over a patio door onto a wall).



Blinds Child Safety Awareness: Keep all cords and chains out of the reach of children using the safety hook, which has been provided for you. Loose cords or chains should never be tied together.



CARING FOR YOUR BLINDS

Following simple tips to care for a blind will ensure they look at their best for longer.

ROMAN BLINDS

We recommend Roman Blinds are cleaned with the upholstery brush on a vacuum cleaner. The fabric part of the blind can be dry cleaned as a last resort, please follow the below steps:

Step 1. Ensure the fabric part of the blind is laid flat (not retracted) on a clean, flat surface.

Step 2. Remove the fabric part of the blind from the headrail/cassette by detaching the Velcro strip either on the front (classic option), or inside the cassette (EVO option).

Step 3. Turn the blind over (face side down), carefully unclip the clear plastic hooks on the cords from the plastic anchor on the blind.

Step 4. The fabric part of the blind is now fully removed from the headrail/cassette and ready for dry cleaning.

Step 5. To reattach, follow the same process as above in reverse. Ensure the cords are fully extended so the maximum drop is achieved

ROLLER AND VERTICAL BLINDS

There are many different types of fabrics used for Roller Blinds. For waterproof fabrics, a damp cloth can be used to gently wipe over the blind. For sheer or translucent fabrics, use a dry, lint free cloth only.

ZEBRA ROLLER BLINDS

The special panelled fabric is very delicate so care must be taken when cleaning. To remove any dust from the blind, use a dry, lint free cloth only.

Due to the delicate nature of Zebra blinds, you may find some threads hanging out. You can simply use a pair of scissors to carefully snip these off at the time of installation.

