

Roman Blind Fitting Instructions

Cassette Headrail

BLINDS CHILD SAFETY AWARENESS

Keep all cords and chains out of the reach of children. Loose cords or chains should never be tied together.

Parts Identified

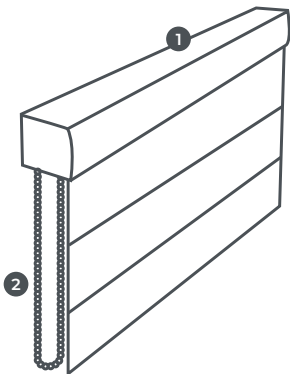

- 1 Cassette
- 2 Control Chain

Additional Parts



Tools Required



Fitting Instructions

1. Measure

The brackets need to be positioned 50mm in from each side of the blind. Using your tape measure, mark these points with a pencil. Evenly space additional brackets between the two end brackets.

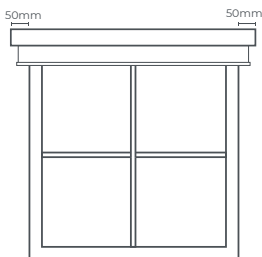

2. Fix Brackets

Choose whether you need to fit your brackets via top fix or face fix. Hold the brackets up to the pencil marks made in Step 1. Mark the relevant hole with a pencil. Drill holes and use suitable screws to fix the brackets. With a spirit level, check the brackets are level.

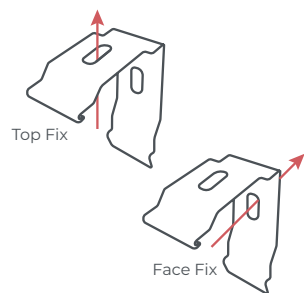

3. Hook, Tilt, Click

When the brackets are fitted, hook the ridge on the top of the cassette into the front of the brackets then push and tilt the cassette back until it clicks into the back part of the bracket.

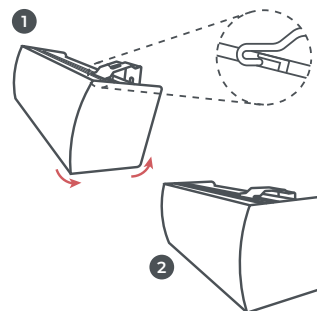

4. Remove Transit Clip

Remove transit clip and discard.

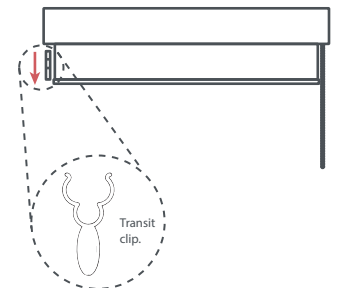

Child Safety

Tensioning Device

Tensioning device must be attached at 1.5m above the ground. Ensure the chain is fully taut.

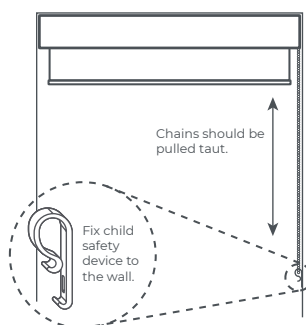

Cord Safety

The cords on the back are connected to breakaway clips which disconnect when weight is put on the cords.

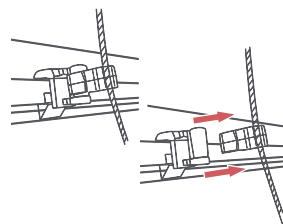

Removing the Blind

Unclip from Brackets

Press the release tab on all brackets. Tilt cassette backwards and ease out of brackets.

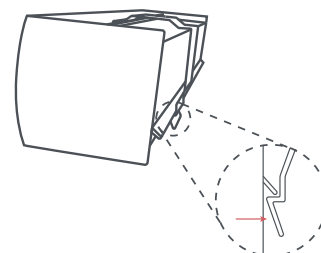

Cleaning Instructions

Use a dry lint free cloth to wipe over the fabric of the blind.

*Before you start fitting your blind make sure the screws are suitable for the surface you are fitting into. Some surfaces will require wall plugs and different screws to the ones we provide.